

AC Series | Direct Wire 120V - 4.3w/ft. - High-Efficacy

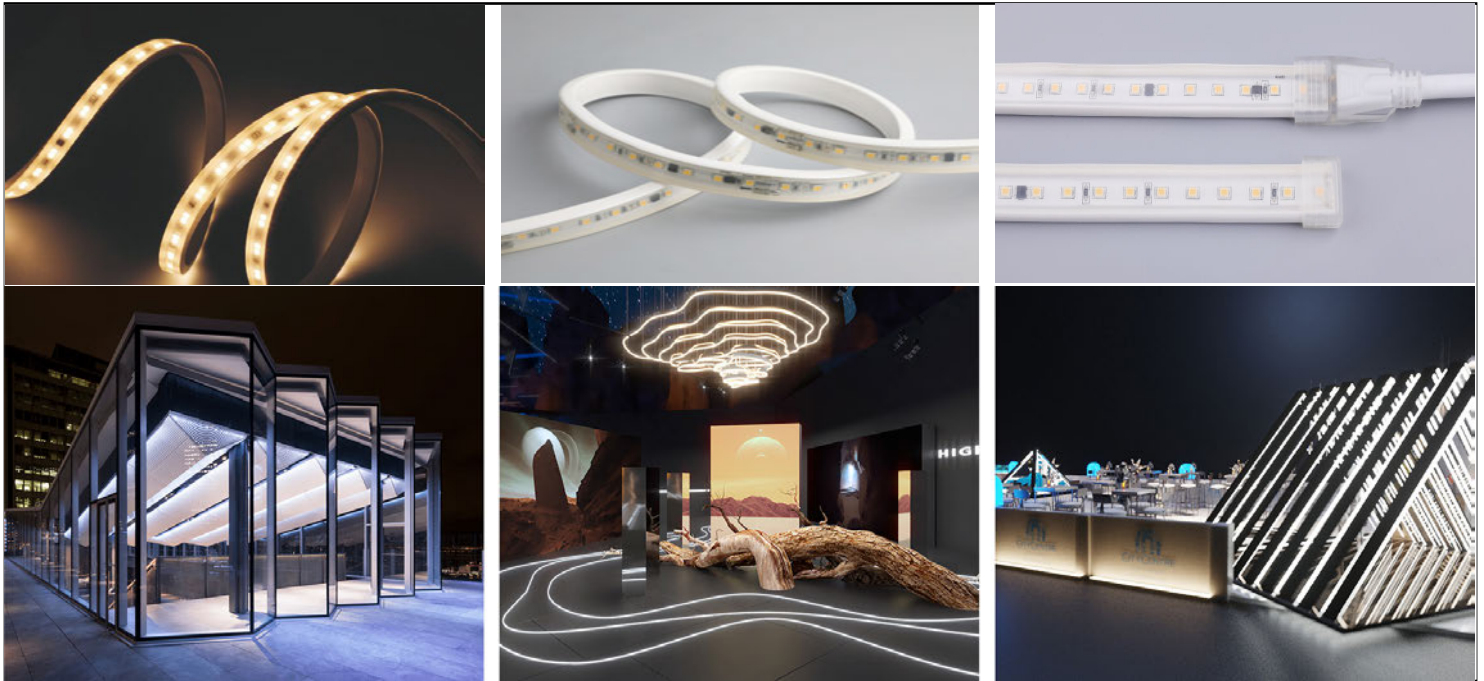

Application

This flexible, 120v strip is ideal for high-end architectural, lighting applications in residential, retail, hospitality and landscape.

Features

- 24 LEDs/foot
- Available in 2700k, 3000k, 3500k, 4000k, and 5000k
- 80+ or 90+ CRI
- Lumen Output: 440lm/ft to 500lm/ft
- Able to cut every 4"
- Max 164ft run length
- Available in IP65 Outdoor & IP40 Indoor
- Dimmable PWM
- ETL listed for indoor dry / wet locations
- 50,000 hours rated lifespan
- Over-voltage, over-current and over temperature protection with on-board smart IC driver

FSAC

Introducing The Smart Lighting Company's newest upgrade to LED Tape technology! Our 120vac flexible top-bend high-performance lighting with run lengths up to 164ft and is IP65 rated for indoor or outdoor wet locations. Advanced PVC raw material exclusive for outdoor usage, with strong weather resistance in UV resistant and flameproof.

Easily customizable with cutting sections every 4 inches, The FSAC series is dimmable, with five different options for color temperature. The Patent driverless design, with on-board constant current IC driver and rectifier, allows for direct AC power supply without an external driver.



Specifications and Performance

	FSAC
Watts per Foot	4.3w/ft.
Max Run Length	164 ft
Cuttable	4"
Lumens per Foot	385-440lm
Lumens per Watt	90-103lm/w
CRI	80+
Input Voltage	120vac
Beam Spread	120°
LED Lifespan	L70 ≥50,000 @ Tc ≤ 65
Dimming	PWM
Dimensions	IP65 (0.65" X 0.28")
CCT	2700k, 3000k, 3500k, 4000k, 5000k, 6500k
Operating Temp	-4°F to 113°F (-20°C to 45°C)
Ambient Temp	-4°F to 113°F (-20°C to 45°C)
Environment	IP65
Warranty	5 year (indoor) 3 Year (outdoor)
Certifications	ETL, RoHS, LM-80, TM-21
LEDs/ft	24 LED's/ ft
SCDM	3 Step, 1 Bin
Mounting	Clips or channel

Ordering Information

Example: FSAC-4.3-xxK-xxL-xxIP-xxCRI-120vac

Max run 164ft

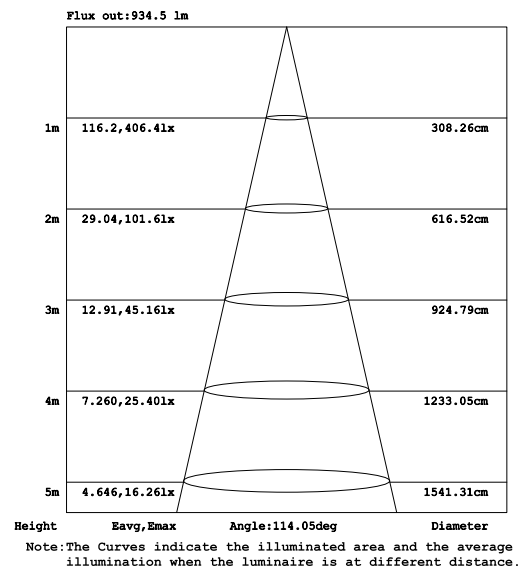
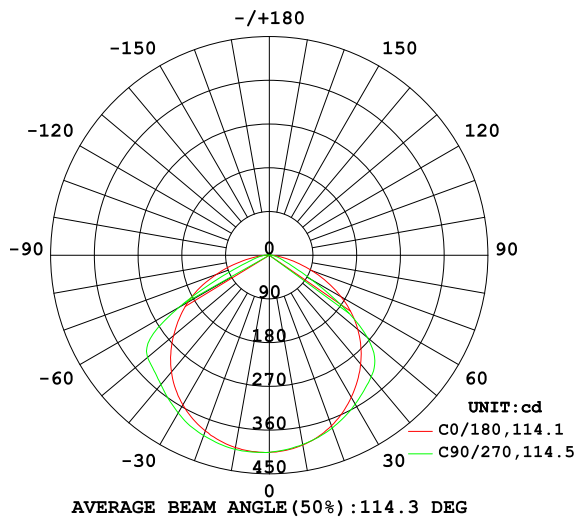

Part No.	Watts/ft		Color Temp		Length	IP Rating		CRI		Voltage	
	4.3	4.3w/ft.	27	2700k		164	Outdoor	80	80+	AC	120VAC
FSAC			30	3000k	164ft Custom length	IP65	Outdoor	90	90+		
			35	3500k							
			40	4000k							
			50	5000k							

Lighting Distribution







Accessories



Wire Lead Accessory

Part No.	Specification	Photo
AL-FSAC-120-PF-PLUG	Wire and end cap attached to strip, white SJTW cable, L=500mm, with Plug, IP65	
AL-FSAC-120-19-WL	Wire and end cap attached to strip, white SJTW cable, L=500mm, hardwire without Plug, IP65	

Connection Accessory

Part No.	Specification	Photo
AL-FSAC-120-6J	Jumper Connector (L=0.5FT), 1pcs	
AL-FSAC-120-12J	Jumper Connector (L=1FT), 1pcs	
AL-FSAC-120-SC	Splice Connector, 1pcs	
AL-FSAC-120-RLC	Right/Left Corner Connector, 1pcs	

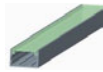
Installation Accessories

Part No.	Specification	Photo
AL-FSAC-120-MBSK	Mounting Bracket and screw kit, 2pcs bracket/kit	
AL-FSAC-120-CH-FLAT	Aluminum channel, flat version, with transparent cover, L=1M	
AL-FSAC-120-CH-TALL	Aluminum channel, tall version, with transparent cover, L=1M	
AL-FSAC-120-SP	Optional IP66 5KV surge protection device (SPD) such as lightning protection for outdoor application (For Hardwire UL1598 Version).	

Hardwire Diagram

Front View

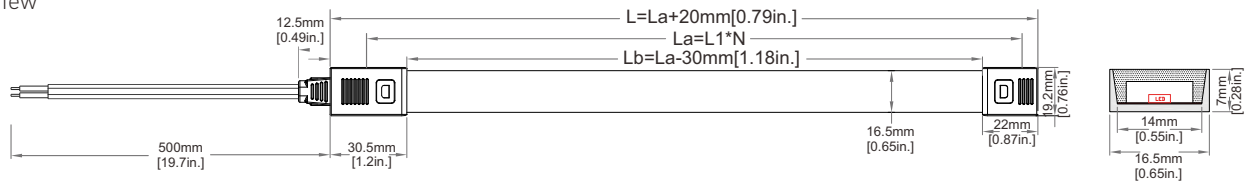

Lateral View



L: Total Length, La: Strip Length, Lb: Light Emitting Length, L1: Strip Increment, N: Quantity in 1,2,3,.....

Dry IP40

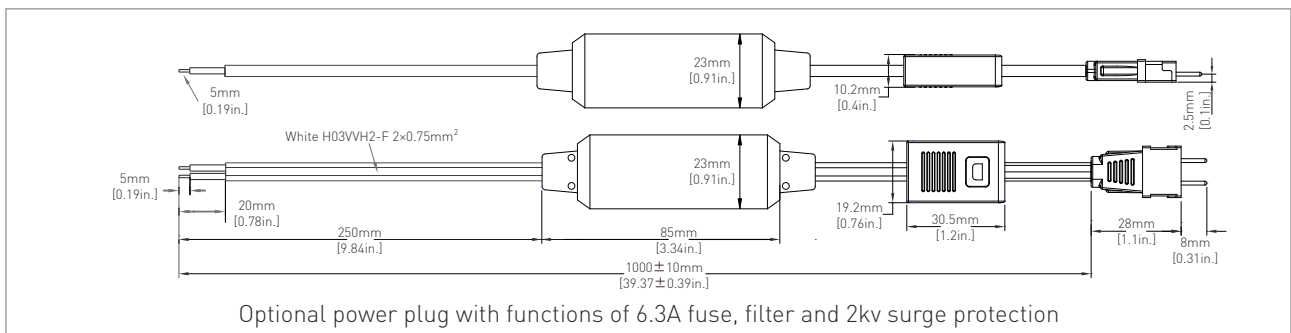

Front View

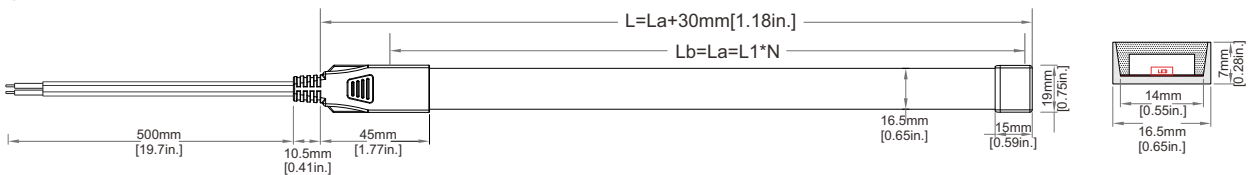

Lateral View



L: Total Length, La: Strip Length, Lb: Light Emitting Length, L1: Strip Increment, N: Quantity in 1,2,3,.....

Wet IP65

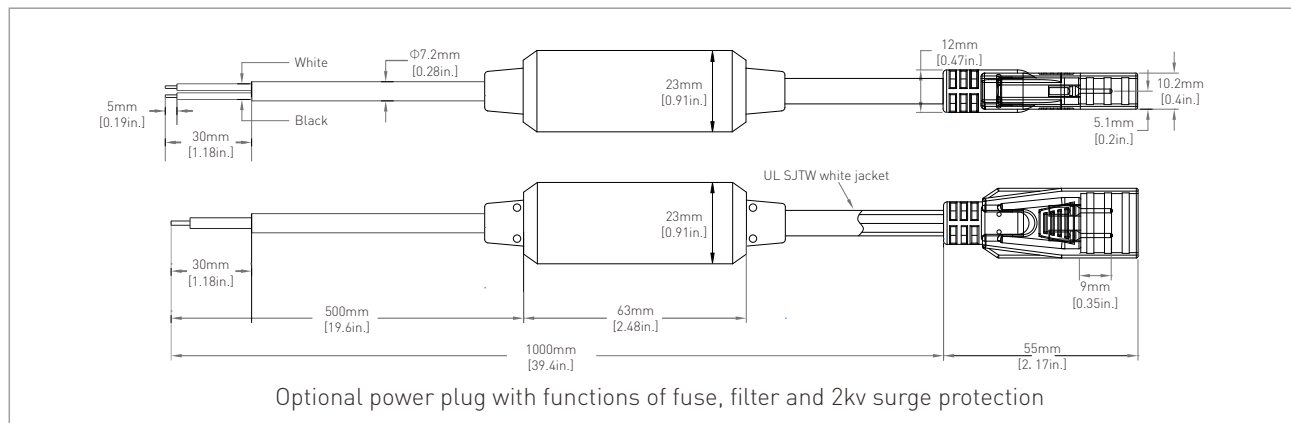

Plug-in Diagram

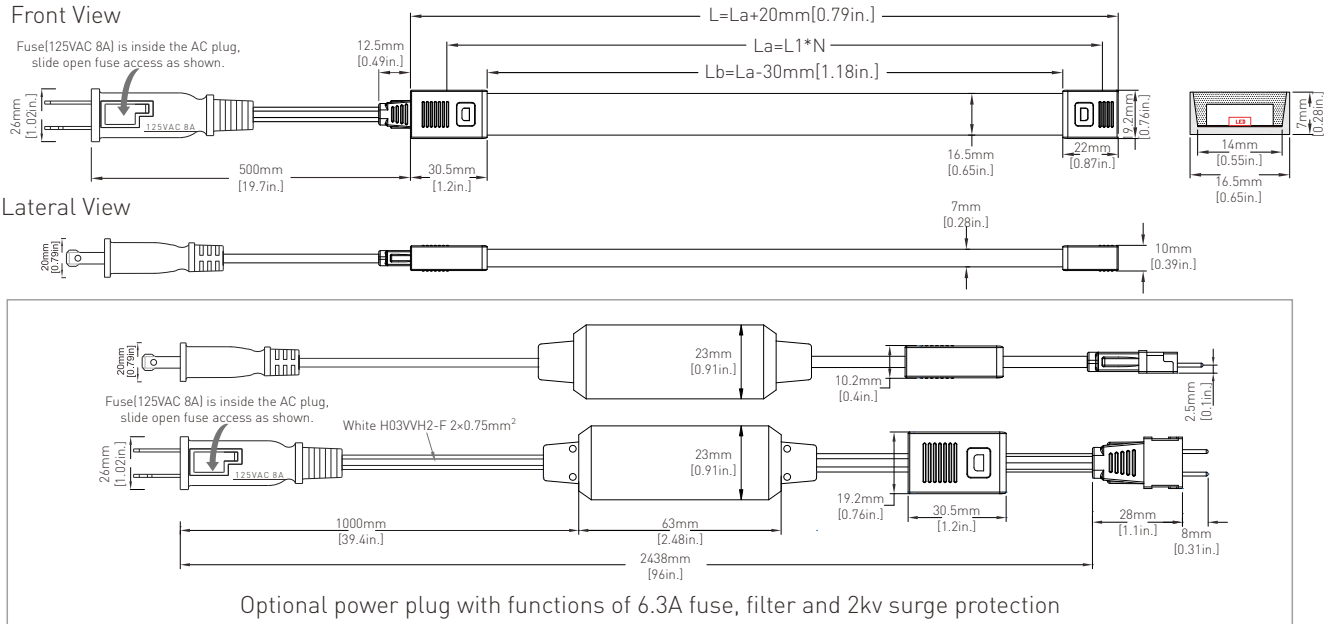

L: Total Length, La: Strip Length, Lb: Light Emitting Length, L1: Strip Increment, N: Quantity in 1,2,3.....

Dry IP40

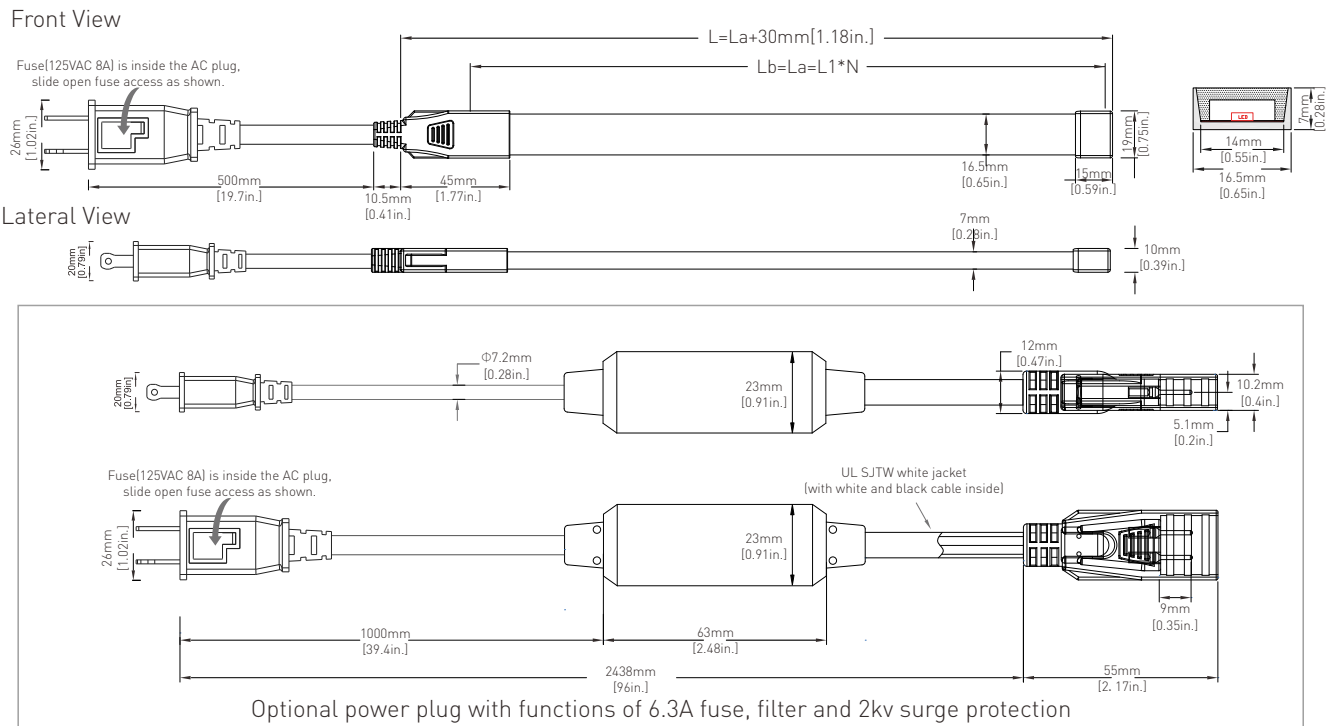

L: Total Length, La: Strip Length, Lb: Light Emitting Length, L1: Strip Increment, N: Quantity in 1,2,3.....

Wet IP65

Assembly Accessories

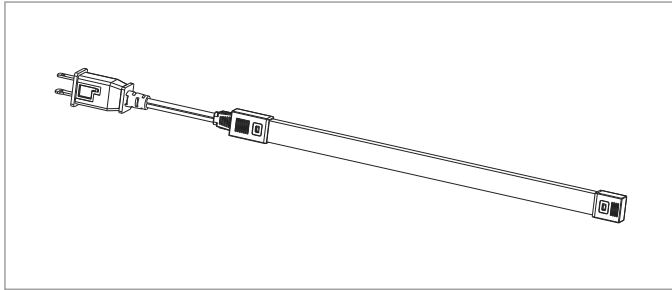

IP40 (Strip Body)

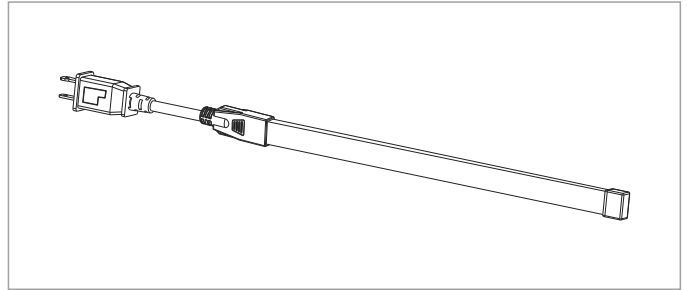

IP65 (Strip Body)

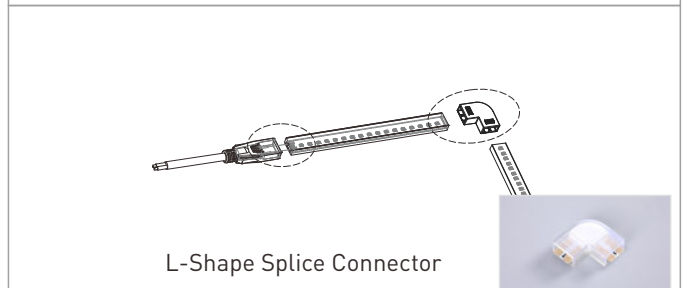
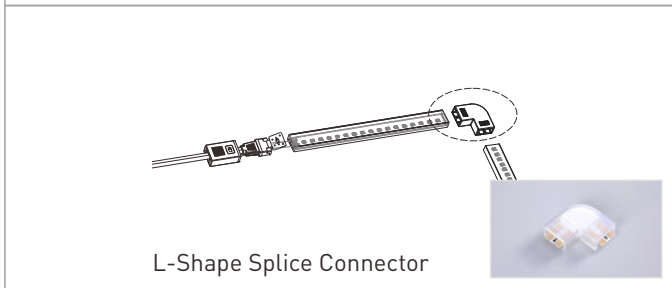
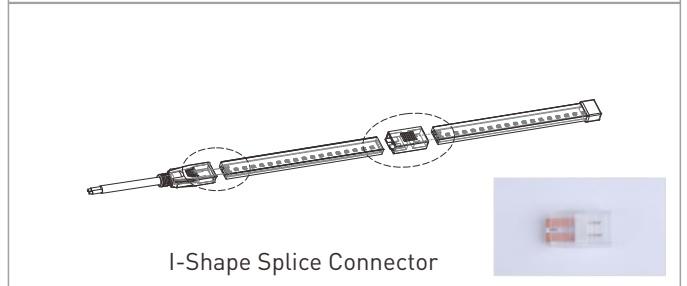
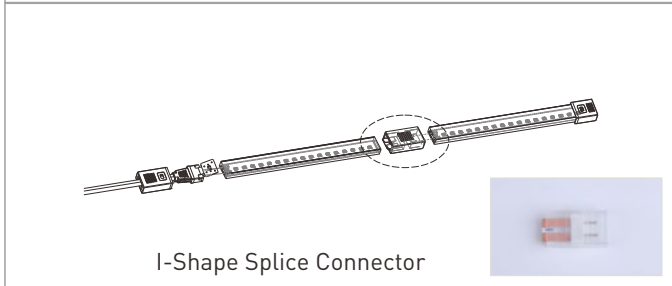
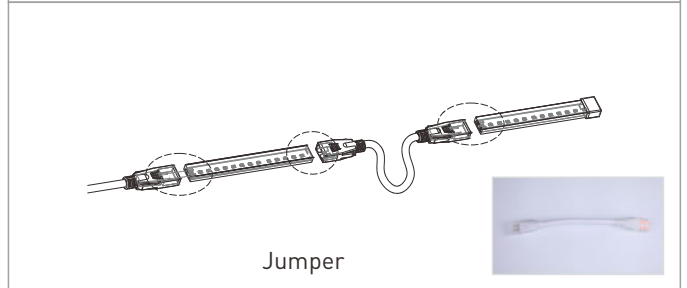
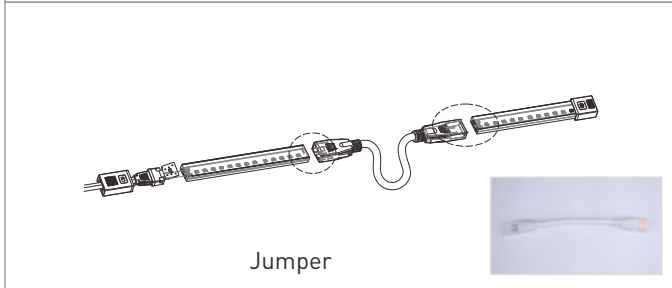
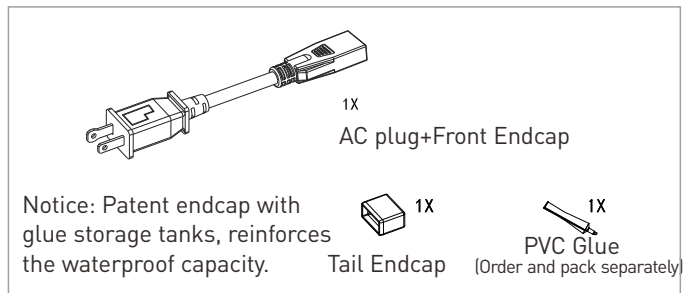
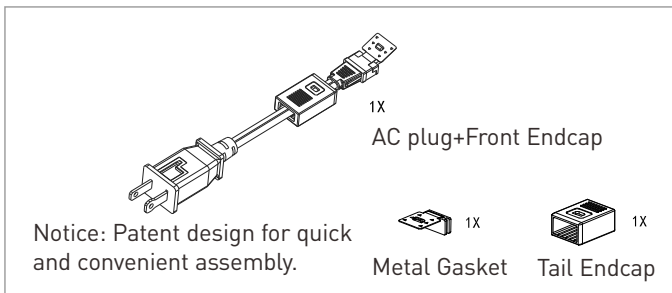

IP40 (Accessories Pack)

IP65 (Accessories Pack)

- Hardwire version complied with UL1598 -
IMPORTANT SAFETY INSTRUCTIONS

- a) "READ AND FOLLOW ALL SAFETY INSTRUCTIONS"
- b) "Do not cover this product as the covering may cause the flexible light to overheat and melt or ignite."
- c) "Do not operate with the flexible light tightly coiled".d) "Do not puncture, cut, shorten, or splice the flexible lighting."
- e) "Do not route the cord or flexible lighting through walls, doors, windows or any like part of the building structure."
- f) "Do not use if there is any damage to the light or cord insulation. Inspect periodically."g) "Do not submerge flexible light in liquids, or use the product in the vicinity of standing water or other liquids."
- h) "Secure this flexible light using only the hangers or clips provided. Do not secure this product or its cord with staples, nails, or like means that may damage the insulation or permanently attach to the building structure."
- i) "Do not subject flexible lighting to continuous flexing."

"SAVE THESE INSTRUCTIONS"

WARNING:

When using outdoor use portable lighting products, basic safety precautions should always be followed to reduce the risk of fire, electric shock, and personal injury, including the following:

Read All Instructions

- a) Ground Fault Circuit Interrupter (GFCI) protection should be provided on the circuits or outlet to be used for the outdoor use flexible lighting product. Receptacles are available having built-in GFCI protection for this measure of safety.

Caution

